

Hy-Grade  
**MILLWORK**

DRAWN BY: IO

SCALE: 1:1

HY-PN1

REV 0

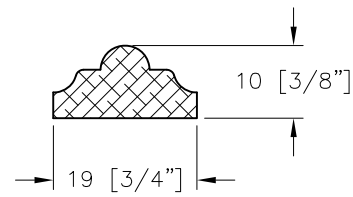

Hy-Grade  
**MILLWORK**

DRAWN BY: IO

SCALE: 1:1

HY-PN2

REV 0

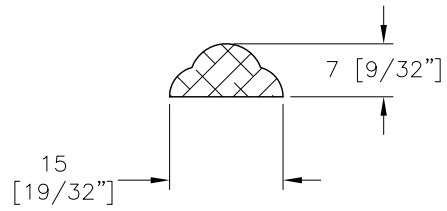

Hy-Grade  
**MILLWORK**

DRAWN BY: IO

SCALE: 1:1

HY-PN3

REV 0

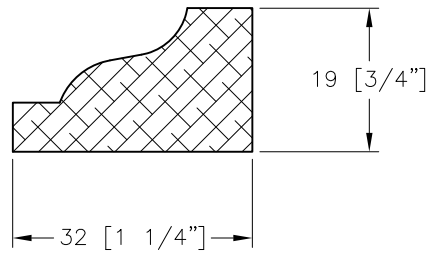

Hy-Grade  
**MILLWORK**

DRAWN BY: IO	SCALE: 1:1
HY-PN4	REV 0

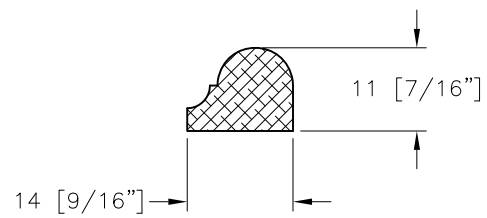

**Hy-Grade**  
**MILLWORK**

DRAWN BY: IO	SCALE: 1:1
HY-PN5	REV 0

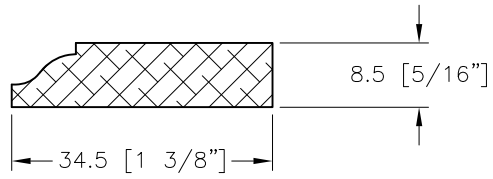

Hy-Grade  
**MILLWORK**

DRAWN BY: IO	SCALE: 1:1
HY-PN6	REV 0

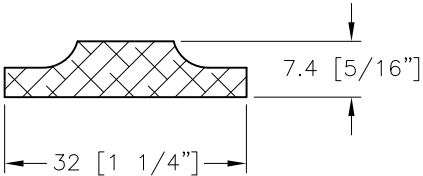

**Hy-Grade**  
**MILLWORK**

DRAWN BY: IO	SCALE: 1:1
HY-PN7	REV 0

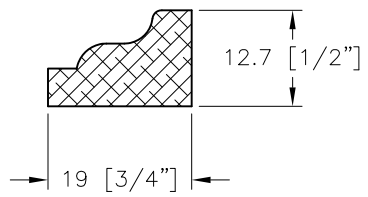

**Hy-Grade**  
**MILLWORK**

DRAWN BY: IO	SCALE: 1:1
HY-PN8	REV 0



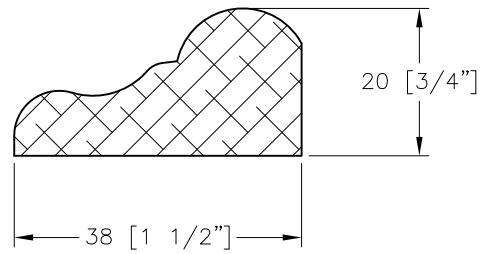

Hy-Grade  
**MILLWORK**

DRAWN BY: IO	SCALE: 1:1
HY-PN9	REV 0

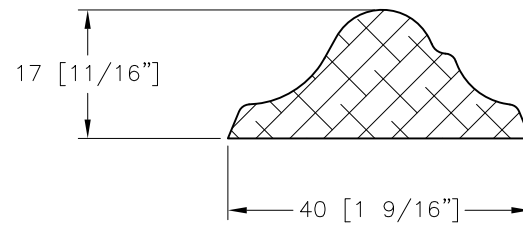

**Hy-Grade**  
**MILLWORK**

DRAWN BY: IO	SCALE: 1:1
HY-PN11	REV 0

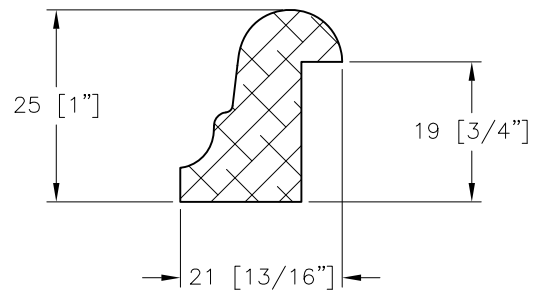

Hy-Grade  
**MILLWORK**

DRAWN BY: IO	SCALE: 1:1
HY-PN12	REV 0

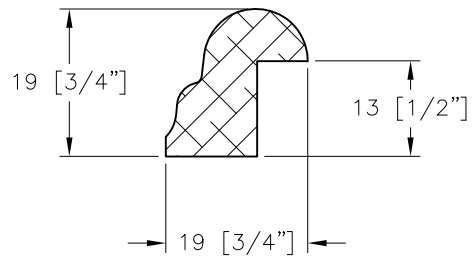

Hy-Grade  
**MILLWORK**

DRAWN BY: IO

SCALE: 1:1

HY-PN13

REV 0

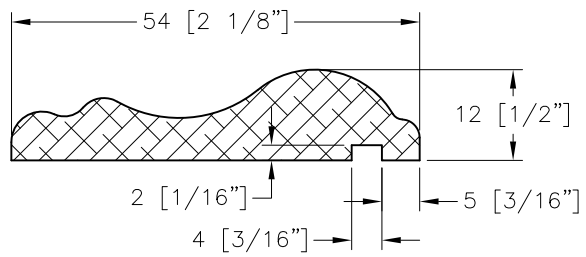

Hy-Grade  
MILLWORK

DRAWN BY: IO	SCALE: 1:1
HY-PN14	REV 0

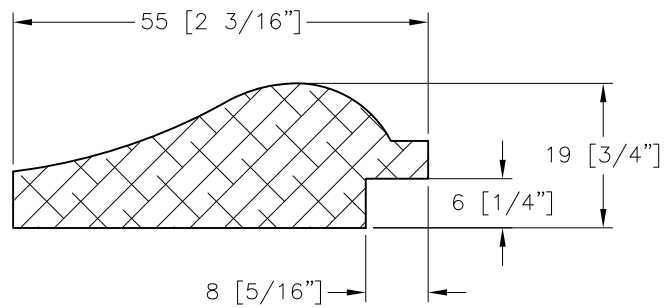

HyGrade  
**MILLWORK**

DRAWN BY: IO

SCALE: 1:1

HY-PN15

REV 0

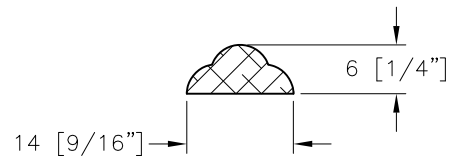

HyGrade  
**MILLWORK**

DRAWN BY: IO	SCALE: 1:1
HY-PN16	REV 0

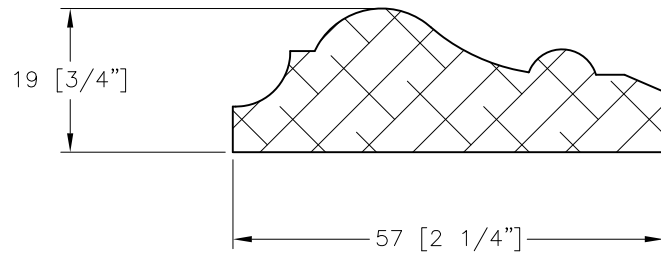

HyGrade  
**MILLWORK**

DRAWN BY: IO	SCALE: 1:1
HY-PN17	REV 0



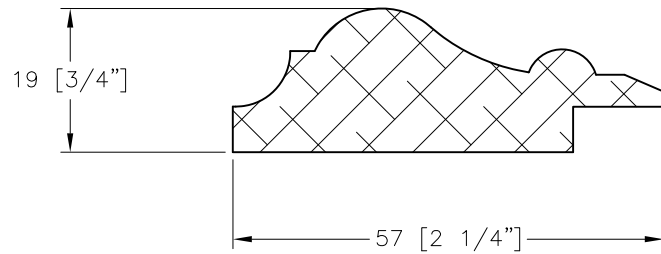

HyGrade  
**MILLWORK**

DRAWN BY: IO	SCALE: 1:1
HY-PN24	REV 0

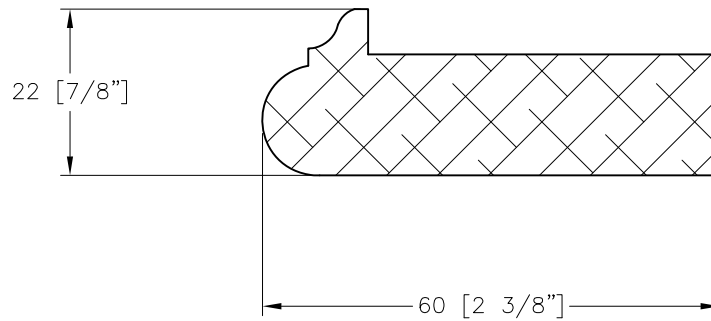

HyGrade  
**MILLWORK**

DRAWN BY: IO	SCALE: 1:1
HY-PN25	REV 0

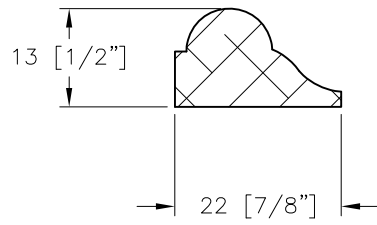

HyGrade  
**MILLWORK**

DRAWN BY: IO	SCALE: 1:1
HY-PN26	REV 0

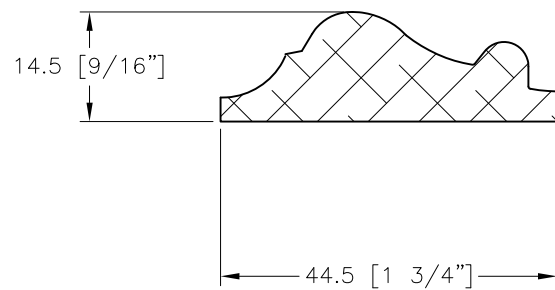

HyGrade  
**MILLWORK**

DRAWN BY: IO	SCALE: 1:1
HY-PN28	REV 0

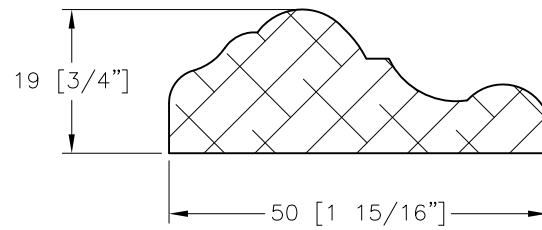

HyGrade  
**MILLWORK**

DRAWN BY: IO	SCALE: 1:1
HY-PN29	REV 0

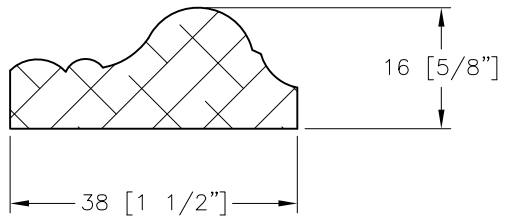

**HyGrade**  
**MILLWORK**

DRAWN BY: IO	SCALE: 1:1
HY-PN30	REV 0

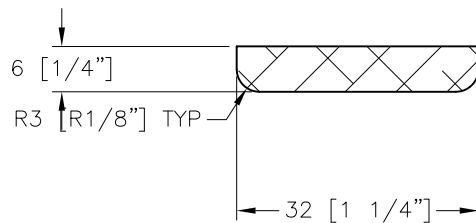

HyGrade  
**MILLWORK**

DRAWN BY: IO	SCALE: 1:1
HY-PN31	REV 0

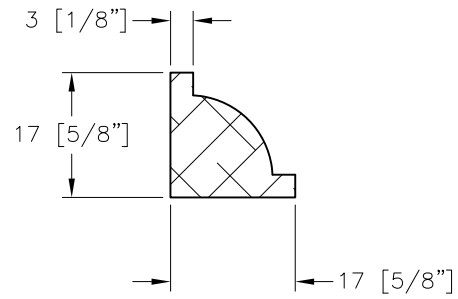

HyGrade  
**MILLWORK**

DRAWN BY: IO	SCALE: 1:1
HY-PN32	REV 0



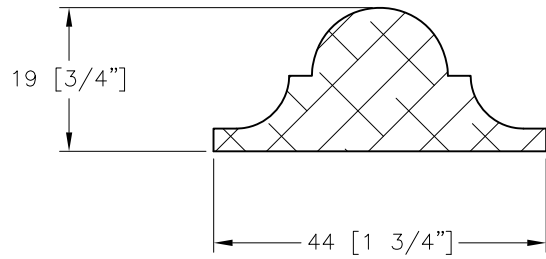

HyGrade  
**MILLWORK**

DRAWN BY: IO	SCALE: 1:1
HY-PN33	REV 0